



MARQUIS
DANCE CLUB SERIES

MD46

High Power 4-Way Loudspeaker
with 2 x 15" LF Drivers

Professional Series

Key Features:

- ▶ Dual JBL 2265H 3" dual voice coil – dual magnetic gap Differential Drive® woofers
- ▶ JBL CMCD-82H 8" cone midrange compression driver
- ▶ JBL 2432H 3" diaphragm, 1.5" exit compression driver
- ▶ 60° x 40° PT™ Progressive Transition waveguide
- ▶ Dual JBL Selenium ST400 Super Tweeters
- ▶ 4-way quad-amplified system

Applications:

- ▶ Sophisticated dance clubs
- ▶ Anywhere high energy dance music is required

JBL's Marquis Dance Club Series is a state-of-the-art family of loudspeaker systems designed specifically for the Dance Club Market. MD46 is a high-power 60° x 40° dual 15" low-frequency system utilizing dual 2265H Differential Drive transducers, CMCD82H 8" mid-range driver, 2432H 3" diaphragm compression driver, and dual ST400 super tweeters.

All of the Marquis Series loudspeakers offer unprecedented fidelity, clarity, and breathtaking purity.



Specifications:

System:	
Frequency Range (-10 dB):	42 Hz – 20 kHz
Frequency Response (±3 dB):	48 Hz – 19 kHz
Coverage Pattern:	60° x 40°, rotatable waveguide
Directivity Factor (Q):	20
Directivity Index (DI):	13 dB
Crossover Modes:	Quad-amp
Crossover Frequencies:	270 Hz, 2.6 kHz and 10 kHz
System Impedance:	LF: 4Ω MF: 8Ω HF: 8Ω UHF: 4Ω
System Power Rating (IEC):	LF: 1600 W (4800 W peak), 2 hrs MF: 550 W (1400 W peak), 2 hrs HF: 75 W (300 W peak), 2 hrs UHF: 130 W (520 W peak), 2 hrs
Long-Term System Power Rating (IEC):	LF: 1100 W (4400 W peak), 100 hrs MF: 200 W, 100 hrs HF: 50 W, 100 hrs UHF: 35 W, 100 hrs
Maximum SPL:	LF: 130 dB-SPL cont avg (136 dB peak) MF: 133 dB-SPL cont avg (139 dB peak) HF: 132 dB-SPL cont avg (138 dB peak) UHF: 128 dB-SPL cont avg (134 dB peak)
Transducers:	
<u>Low Frequency Driver:</u>	2 x JBL 2265H 380 mm (15 in) Differential Drive driver with 75 mm (3 in) dual voice coil
Nominal Impedance:	4 ohms
Sensitivity:	101 dB-SPL, 2.83V (2W) @ 1m (3.3 ft)
<u>Midrange Driver:</u>	JBL CMCD-82H Cone Midrange Compression Driver with integral 200 mm (8 in) diameter Differential Drive® dual voice-coil internal driver
Nominal Impedance:	8 ohms
Sensitivity:	112 dB SPL, 2.83V (1W) @ 1m (3.3 ft)
<u>High Frequency Driver:</u>	JBL 2432H, 38 mm (1.5 in) exit compression driver, 75 mm (3 in) voice coil
Nominal Impedance:	8 ohms
Sensitivity:	113 dB-SPL, 2.83V (1W) @ 1m (3.3 ft)
<u>Waveguide:</u>	PT-K64MH
<u>Super Tweeter:</u>	2 x JBL Selenium ST400 Super Tweeter
Nominal Impedance:	4 ohms
Sensitivity:	112 dB SPL, 2.83V (2W) @ 1m (3.3 ft)
Physical:	
Enclosure:	Trapezoidal with 15 degree side angles, 16 mm (5/8 in) exterior grade 11-ply Finnish birch plywood
Suspension Attachment:	13 points (3 top, 3 bottom, 2 each side, 3 rear), M10 threaded hardware
Finish:	Black DuraFlex™ finish.
Grille:	Powder coated 14 gauge perforated steel.
Input Connector:	NL8 Neutrik Speakon® and CE-compliant covered barrier strip terminals. Barrier terminals accept up to 5.2 sq mm (10 AWG) wire or max width 9 mm (.375 in) spade lugs. Speakon in parallel with barrier strip for loop-through.
Dimensions (H x W x D in vertical cabinet orientation):	1524.0 x 559.8 x 653.3 mm (60.0 x 22.0 x 25.8 in)
Net Weight:	65.8 kg (145 lb)
Optional Accessories:	M10 x 35 mm forged shoulder eyebolts with washers

¹IEC shaped pink noise, 6 dB crest factor, 2 hour duration, based on minimum impedance, with recommended active tuning.

²IEC shaped pink noise, 6 dB crest factor, 100 hour duration, with recommended active tuning.

³Calculated based on system sensitivity and 2-hour power rating, exclusive of power compression.

⁴Anechoic sensitivity in free field, no additional sensitivity gain from boundary loading.

JBL continually engages in research related to product improvement. Changes introduced into existing products without notice are an expression of that philosophy.

► MD46 High Power 4-Way Loudspeaker with 2 x 15" LF Drivers

Beamwidth

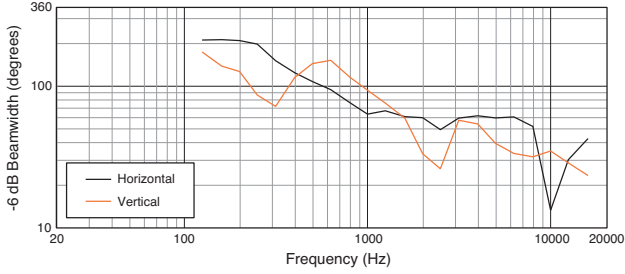

Horizontal Off-Axis Frequency Response

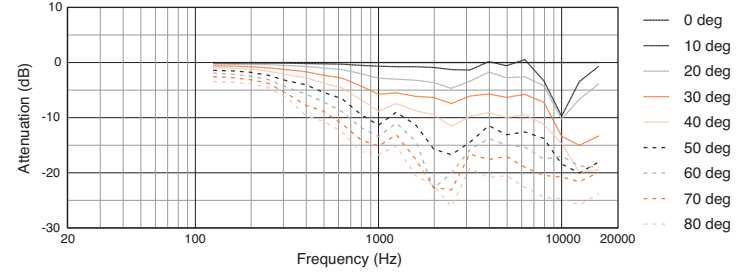

Directivity Index, Q

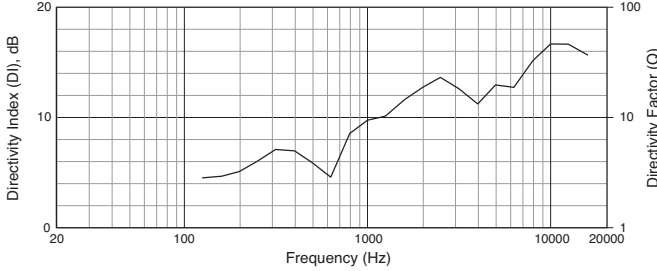

Vertical Up Off-Axis Frequency Response

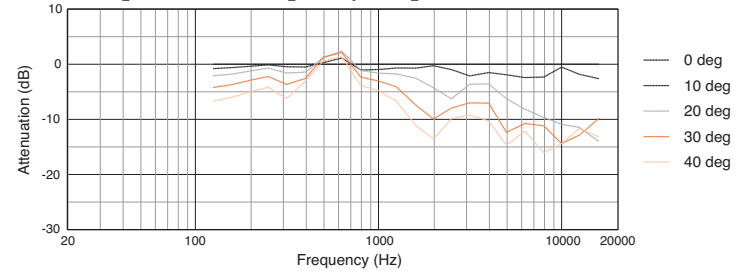

Frequency Response and Impedance

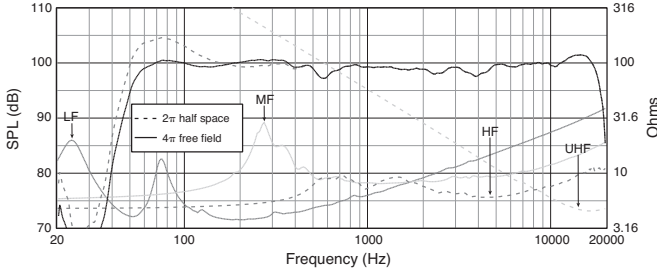

Vertical Down Off-Axis Frequency Response

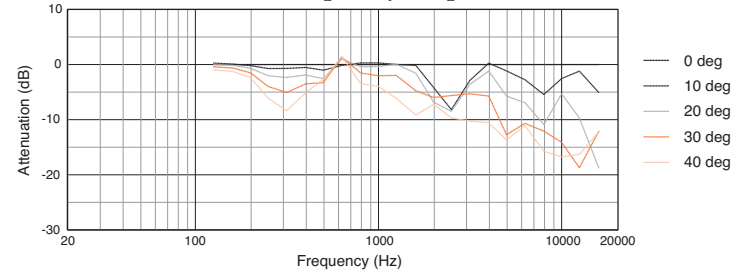

Measurements obtained with recommended active tuning. Graphs are from unaltered measured data.

Dimensions

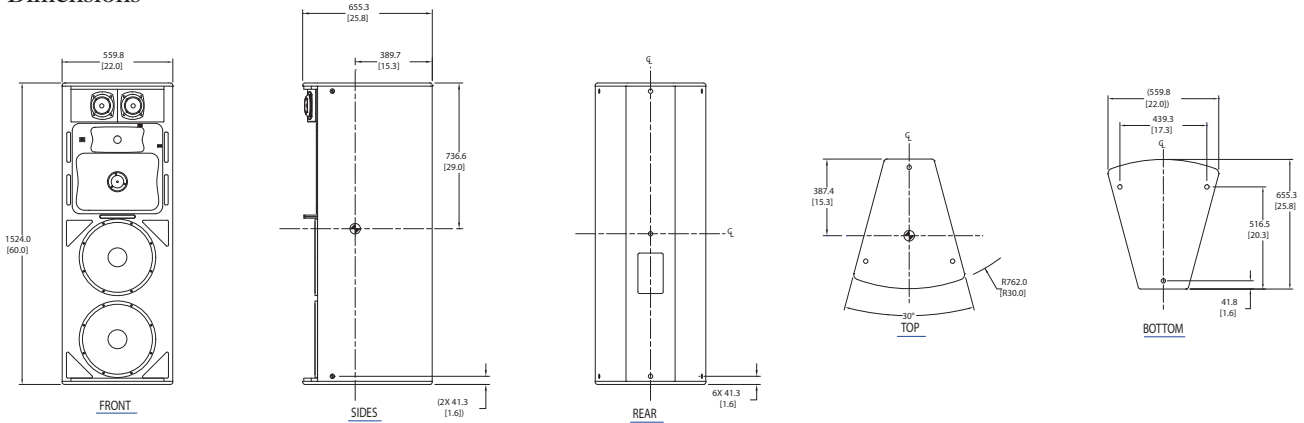

JBL Professional
8500 Balboa Boulevard, P.O. Box 2200
Northridge, California 91329 U.S.A.

© Copyright 2012 JBL Professional
www.jblpro.com

SS MD46
5018067
CRP
03/12