

# MRX512M 12" Two-Way Stage Utility / Monitor Speaker

## Key Features:

- ▶ 12" Differential Drive® woofer for high-power capacity and very lightweight
- ▶ 1.5" annular polymer diaphragm compression driver
- ▶ Compact and low-profile for minimal obstruction of audience sight-lines
- ▶ 70° x 70° coverage for even and smooth response on and off axis
- ▶ Dual-angle pole socket for applications requiring tripod mounting
- ▶ Heavy Duty 16 gauge protective screen backed steel grille
- ▶ Tough DuraFlex™ enclosure finish

## Applications:

- ▶ Speech reinforcement
- ▶ Live performance stage monitoring
- ▶ Reinforcement of vocal and acoustic music
- ▶ High-performance satellite speaker for use with subwoofers

The MRX512M is a premium, utility/monitor speaker. The MRX512M uses a JBL 262H 305 mm (12 in) Differential Drive® woofer and a 2408H 37.5 mm (1.5 in) annular polymer diaphragm, neodymium compression driver for 400 watts (continuous) power capacity. A 70° x 70° horn provides smooth, even coverage whether used in the vertical (mains) or horizontal (monitor) orientation.

NL4 connectors are provided on both ends of the speaker to keep cable runs tidy on stage when used in the monitor application and for easy access when used on tripods. A passive network provides accurate reproduction throughout the cross-over region.

For use on a tripod or over a subwoofer, JBL's dual angle pole mount is included. This feature allows the speaker to be mounted in a vertical position or with a 10° down tilt for optimum audience coverage.

The enclosure is constructed of quality plywood and coated in JBL's rugged DuraFlex™ finish. The attractive CNC-machined, 16-gauge steel grille wraps around the sides of the enclosure. The grilles are internally lined with an acoustically transparent screen to provide additional driver protection and give a very professional appearance.



## Specifications:

Frequency Range (-10 dB):	60 Hz - 20 kHz
Frequency Response (±3 dB):	90 Hz - 20 kHz
Coverage Pattern:	70° x 70° nominal
Crossover Mode:	Passive
Crossover Frequency:	1.7 kHz
Power Rating (Continuous/Program/Peak):	400 W/ 800 W/ 1600 W, 2 hrs <sup>1</sup> 350 W/ 700 W/ 1400 W, 100 hrs <sup>1</sup>
Maximum SPL:	123 dB SPL continuous (129 dB SPL peak) <sup>2</sup>
System Sensitivity (1w @ 1m):	97 dB SPL
LF Driver:	1 x JBL 262H 305 mm (12 in) Differential Drive® woofer
HF Driver:	1 x JBL 2408H 37.5 mm (1.5 in) annular polymer diaphragm, neodymium compression driver
Nominal Impedance:	8 ohms
Enclosure:	Symmetrical stage monitor, 15/18 mm, plywood.
Suspension / Mounting:	Dual angle, 35 mm pole socket
Transport:	Integrated handle / input cup
Finish:	Black DuraFlex™ finish
Grille:	Powder coated, black, 16 gauge perforated steel with acoustically transparent black screen backing.
Input Connectors:	Neutrik® Speakon® NL-4 (x2), one on each end
Dimensions (H x W x D):	645 mm x 380 mm x 345 mm (25.25 in x 15.0 in x 13.5 in)
Net Weight:	14.9 kg (33.0 lbs)
Optional Accessories:	SS2-BK: Tripod speaker stand SS3-BK: Satellite speaker pole

<sup>1</sup> IEC standard, full bandwidth pink noise with 6 dB crest factor for specified period

<sup>2</sup> Calculated based on power rating and sensitivity

JBL continually engages in research related to product improvement. Some materials, production methods and design refinements are introduced into existing products without notice as a routine expression of that philosophy. For this reason, any current JBL product may differ in some respect from its published description, but will always equal or exceed the original design specifications unless otherwise stated.

# ▶ MRX512M 12" Two-Way Stage Utility / Monitor Speaker

## Frequency Response:

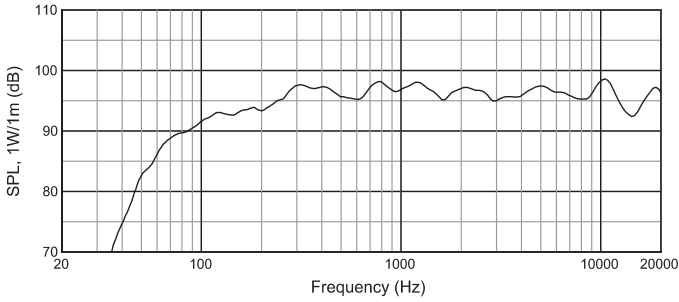

## Block Diagram:

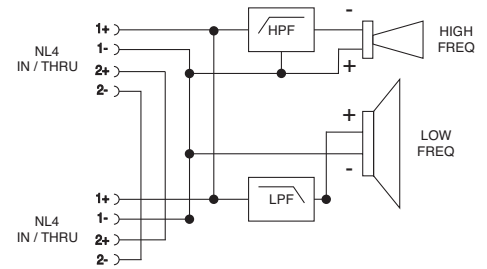
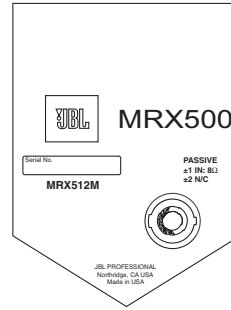

## Beamwidth:

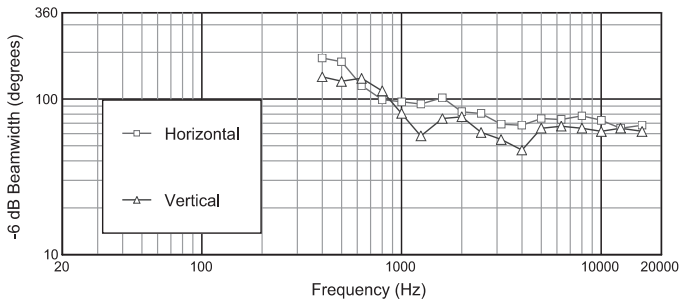

## Directivity Index:

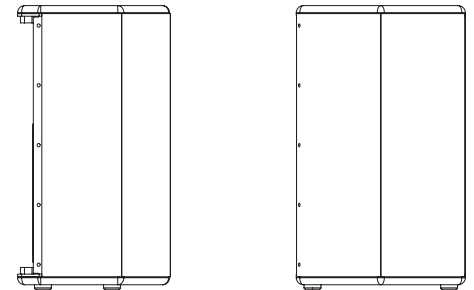
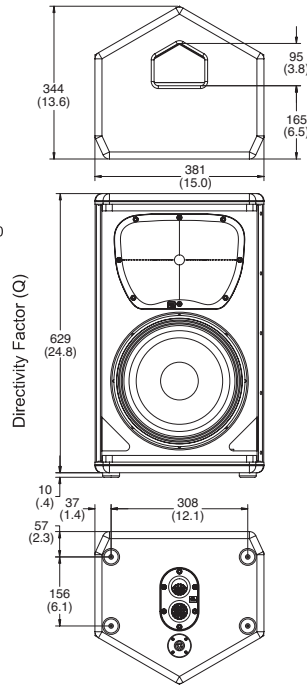
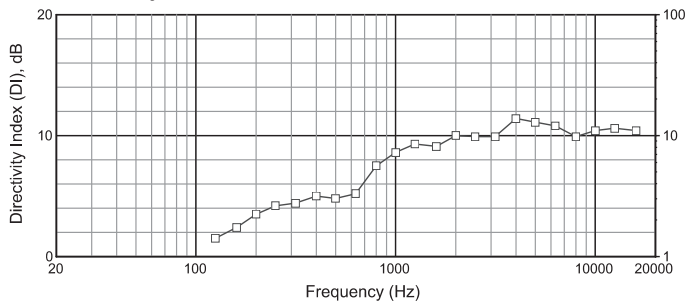

Dimensions in mm (in)



JBL Professional  
8500 Balboa Boulevard, P.O. Box 2200  
Northridge, California 91329 U.S.A.

© A Harman International Company  
© Copyright 2006 JBL Professional

SS MRX512M  
CRP 5M  
03/06