

2" (50 mm) exit compression driver for high sensitivity, low distortion and smooth medium frequency response applications. That leads the D405 driver for deliver high performance, high quality and high value for the pinnacle in sound reinforcement applications.

Its construction features include:

- ferrofluid (Ferrosound®) loaded gap reducing heat build-up and offering consistent results over long-term demanding concert usage;
- voice coil is made of high temperature wire wound on Kapton® former to withstand high operating temperatures;
- injected plastic housing;
- precisely engineered diaphragm structure and alignment mechanism allows for easy, reliable and cost effective repair in case of diaphragm failure.



### SPECIFICATIONS

Nominal impedance	8	Ω
Minimum impedance @ 2,900 Hz	6.8	Ω
Power handling		
Musical Program (w/ xover 500 Hz 12 dB / oct) <sup>1</sup>	150	W
Musical Program (w/ xover 1,000 Hz 12 dB / oct) <sup>1</sup>	200	W
Sensitivity		
On horn, 2.83V@1m, on axis <sup>2</sup>	110	dB SPL
On plane-wave tube, 0.0894V <sup>3</sup>	116	dB SPL
Frequency response @ -10 dB	300 to 7,000	Hz
Throat diameter	50 (2)	mm (in)
Diaphragm material		Phenolic
Voice coil diameter	100 (4)	mm (in)
Re	6.0	Ω
Flux density	1.60	T
Minimum recommended crossover (12 dB / oct)	500	Hz

<sup>1</sup> Power handling specifications refer to normal speech and/or music program material, reproduced by an amplifier producing no more than 5% distortion. Power is calculated as true RMS voltage squared divided by the nominal impedance of the loudspeaker. This voltage is measured at the input of the recommended passive crossover when placed between the power amplifier and loudspeaker.  
Musical Program = 2 x W RMS.

<sup>2</sup> Measured with HL4750-SLF horn, 500 - 3,500 Hz average.

<sup>3</sup> The sensitivity represents the SPL in a 25 mm terminated tube, 500 - 3,500 Hz average.

### ADDITIONAL INFORMATION

Magnet material	Barium ferrite
Magnet weight	2,640 (92) g (oz)
Magnet diameter x depth	200 x 24 (7.87 x 0.95) mm (in)
Magnetic assembly weight	7,740 (17.06) g (lb)
Housing material	Plastic
Housing finish	Black
Magnetic assembly steel finish	Zinc-plated
Voice coil material	Copper
Voice coil former material	Polyimide (Kapton®)
Voice coil winding length	7.0 (23.0) m (ft)
Voice coil winding depth	4.1 (0.16) mm (in)
Wire temperature coefficient of resistance (α25)	0.00329 1/°C
Volume displaced by driver	2.2 (0.078) l (ft³)
Net weight	8,300 (18.30) g (lb)
Gross weight	8,520 (18.78) g (lb)
Carton dimensions (W x D x H)	23 x 22.5 x 9.7 (9.1 x 8.9 x 3.8) cm (in)

### MOUNTING INFORMATION

Horn connection	Bolt on
Number of holes	4 (M6) equally spaced threaded holes
Threaded holes diameter	102 (4) mm (in)
Connectors	Push terminals
Polarity	Positive voltage applied to the positive terminal (red) gives diaphragm motion toward the throat

### DRIVER x HORN CONNECTION

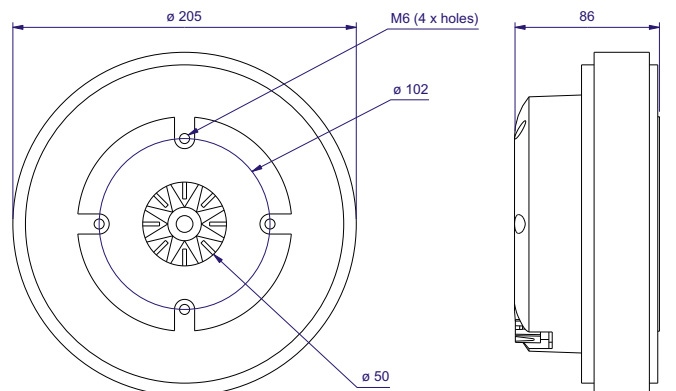
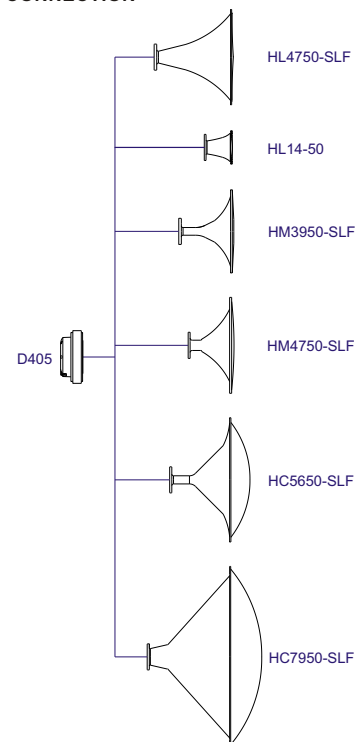

Dimensions in mm.

RESPONSE AND IMPEDANCE CURVES W/ HL4750-SLF HORN INSIDE AN ANECHOIC CHAMBER, 1 W / 1 m

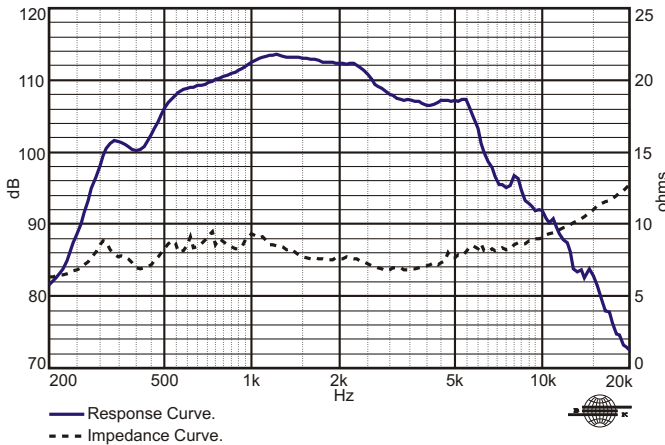

HARMONIC DISTORTION CURVES W/ HL4750-SLF HORN, 10 W / 1 m.

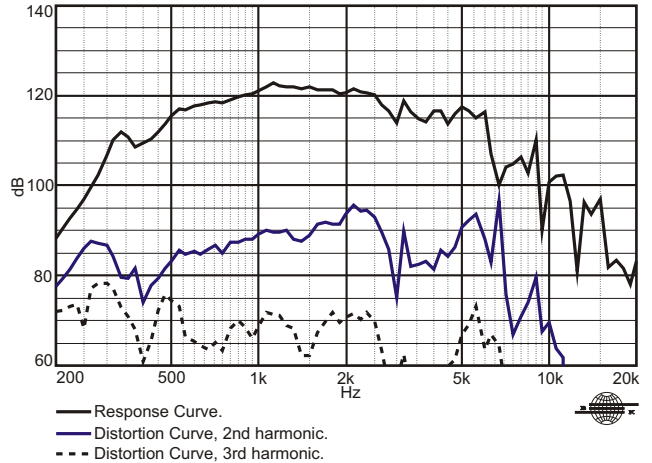

RESPONSE AND IMPEDANCE CURVES W/ PLANE-WAVE TUBE, 1 mW

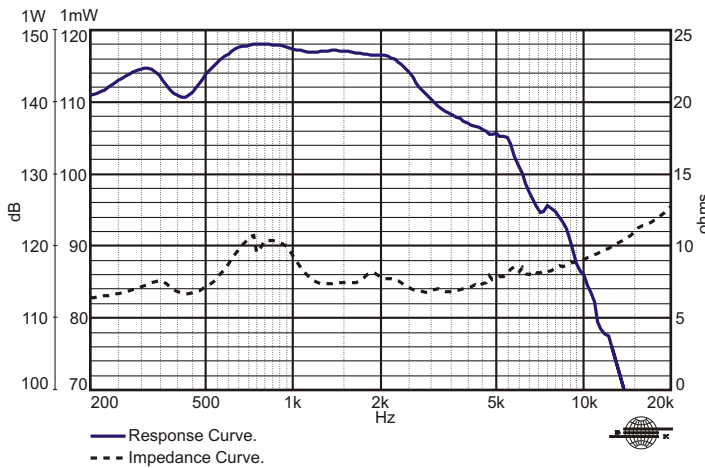

Frequency response and impedance curves measured with 50 mm terminated plane-wave tube, with sensitivity referenced to a 25 mm tube.

POLAR RESPONSE CURVES

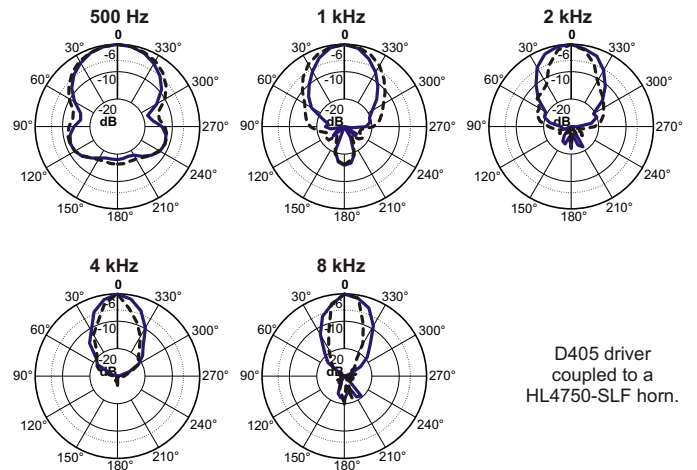

D405 driver coupled to a HL4750-SLF horn.

— Polar Response Curve, Horizontal.  
- - - Polar Response Curve, Vertical.

HARMONIC DISTORTION CURVES W/ HL4750-SLF HORN, 1 W / 1 m.

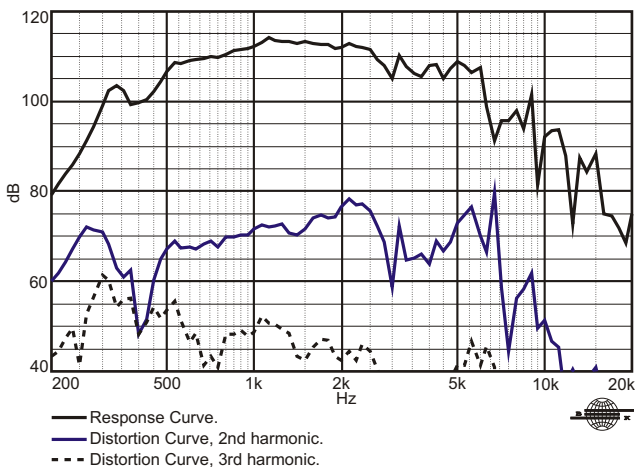

### HOW TO CHOOSE THE RIGHT AMPLIFIER

The power amplifier must be able to supply twice the RMS driver power. This 3 dB headroom is necessary to handle the peaks that are common to musical programs. When the amplifier clips those peaks, high distortion arises and this may damage the transducer due to excessive heat. The use of compressors is a good practice to reduce music dynamics to safe levels.

### FINDING VOICE COIL TEMPERATURE

It is very important to avoid maximum voice coil temperature. Since moving coil resistance ( $R_e$ ) varies with temperature according to a well known law, we can calculate the temperature inside the voice coil by measuring the voice coil DC resistance:

$$T_B = T_A + \left( \frac{R_B}{R_A} - 1 \right) \left( T_A - 25 + \frac{1}{\alpha_{25}} \right)$$

$T_A, T_B$  = voice coil temperatures in °C.

$R_A, R_B$  = voice coil resistances at temperatures  $T_A$  and  $T_B$ , respectively.

$\alpha_{25}$  = voice coil wire temperature coefficient at 25 °C.

Kapton®: Du Pont trademark.

Ferrosound®: Ferrofluidics Corporation trademark.